



LIONSCLUB

HEUSDEN – DRUNEN
DE LANGSTRAAT

LIONS HEUSDEN LANGSTRAATRALLY

ZONDAG **2**
M E I **21** **0**
1
7





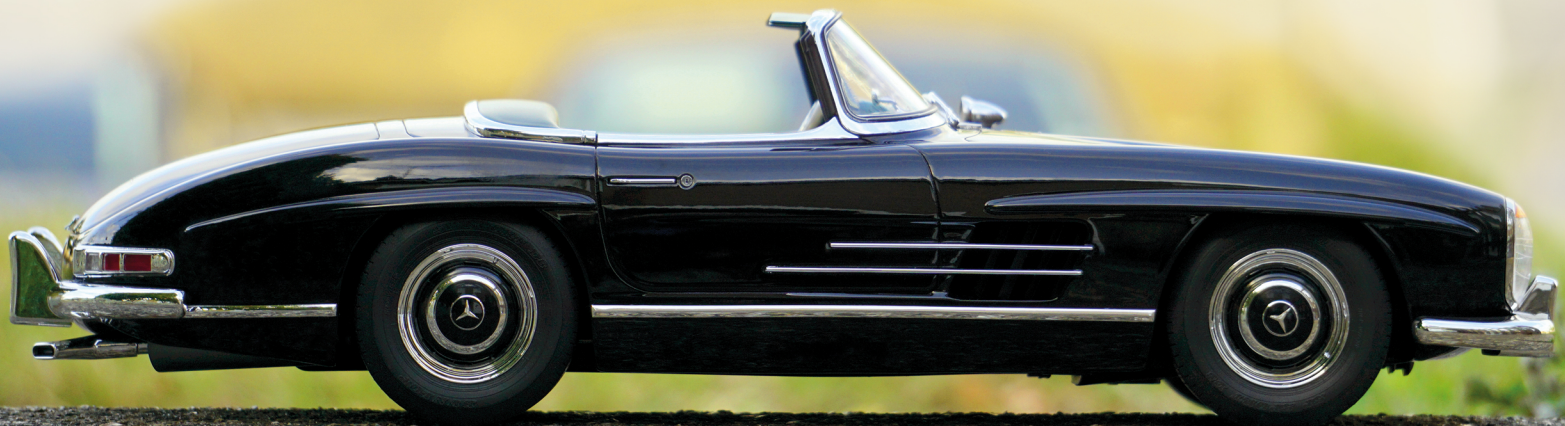

Stichting
Paardensport
Gehandicapten

—
goede doel oa.



JM VAN DELFT & ZN

GEVELBOUWERS SINDS 1907

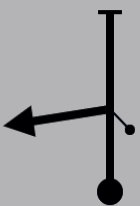
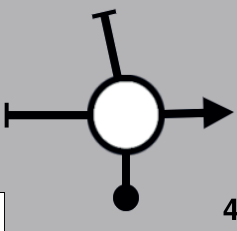
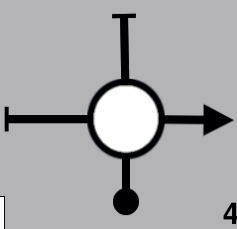
From TC 2 Lunch		DISTANCE: 49,49 Km		DAY: 21 mei 17				
To TC 3 Thee		RECORD: 3		SECTION: 3				
SPECIAL STAGE 2		TIME ALLOWED: min						
Heusden Langstraat Rally 49,49 Km								
DISTANCE		DIRECTION	INFORMATION	DISTANCE REGRESS				
TOTAL	PARTIAL							
0,00	0,00	 <div style="display: flex; justify-content: space-between; align-items: center;"> 1 49,49 </div>	 START SS 2 Heusden 49,49 Km  <table border="1" style="font-size: small;"> <tr><td>N-051°38.744</td></tr> <tr><td>E-005°12.241</td></tr> <tr><td>ALT: 12 m</td></tr> </table>	N-051°38.744	E-005°12.241	ALT: 12 m		49,49
N-051°38.744								
E-005°12.241								
ALT: 12 m								
0,23	0,23	 <div style="display: flex; justify-content: space-between; align-items: center;"> 2 49,26 </div>	Let op: vanaf hier fotovragen.		49,26			
1,34	1,11	 <div style="display: flex; justify-content: space-between; align-items: center;"> 3 48,15 </div>			48,15			
1,38	0,04	 <div style="display: flex; justify-content: space-between; align-items: center;"> 4 48,11 </div>			48,11			
3,00	1,62	 <div style="display: flex; justify-content: space-between; align-items: center;"> 5 46,49 </div>	Zandkantseweg		46,49			
4,28	1,28	 <div style="display: flex; justify-content: space-between; align-items: center;"> 6 45,21 </div>			45,21			
5,36	1,08	 <div style="display: flex; justify-content: space-between; align-items: center;"> 7 44,13 </div>			44,13			

PROXIMA NOTA
PROCH NOTE
NEXT NOTE

2,04



Stichting Paardensport Gehandicapten Langstraat e.o.

maakt paardrijden voor mensen met een beperking mogelijk in de regio midden Brabant. Bij onze stichting rijden mensen met een zware beperking (zowel lichamelijk als verstandelijk), maar ook ruiters met een lichte beperking. Dit gemengde gezellige gezelschap rijdt in kleine groepjes paard op basis van hun mogelijkheden. Een hobby waar je het plezier vanaf ziet druipen, wat kijken de ruiters daar elke week weer naar uit. Paardrijden is niet alleen maar heel leuk om te doen, maar is ook heel erg goed voor de ruiters. Paardrijden heeft een revaliderende en therapeutische werking. Wat wij bij veel ruiters dan ook vaak zien is een verbetering van de conditie en balans, maar ook het sociale aspect is erg belangrijk.



Alle betrokkenen bij de stichting doen dit op vrijwillige basis; het bestuur, de instructeurs en begeleiders. De ruiters betalen lesgeld, maar hiervan kan de stichting niet rond komen. Paardrijden voor mensen met een beperking is duur, omdat er meerdere aanpassingen nodig zijn, zoals een tillift, en speciale zadels en teugels. De ruiters hebben vaak een klein budget, waardoor wij aan deze doelgroep niet het benodigde lesgeld kunnen vragen. Daarom zijn we altijd opzoek naar vrienden en bedrijven die, net als wij, het paardrijden voor deze doelgroep mogelijk willen maken!

Met uw financiële hulp kunnen deze ruiters wekelijks rijden op hun viervoetige vriend. Door vriend te worden, helpt u mee aan het voortbestaan van deze prachtige stichting.

Meer informatie kunt u vinden op www.spglangstraat.nl.

Namens het bestuur van SPG Langstraat e.o. bedankt voor uw aandacht en veel succes met de Heusden Langstraat Rally

From TC 2 Lunch		DISTANCE: 49,49 Km		DAY: 21 mei 17	
To TC 3 Thee		RECORD: 3		SECTION: 3	
SPECIAL STAGE 2		TIME ALLOWED: min			
Heusden Langstraat Rally		49,49 Km			
DISTANCE		DIRECTION	INFORMATION	DISTANCE REGRESS	
TOTAL	PARTIAL				
7,40	2,04	 8 42,09	 Ontheffing verleend..... Max. 30 km/u		42,09
9,61	2,21	 9 39,88	 Bij passeren van Camping Duinhoeve voorzichtig!		39,88
10,30	0,69	 10 39,19			39,19
10,74	0,44	 11 38,75			38,75
12,21	1,47	 12 37,28	Loonse Molenstraat		37,28
13,21	1,00	 13 36,28			36,28
13,87	0,66	 14 35,62			35,62

PROXIMA NOTA
PROCH NOTE
NEXT NOTE

1,53

Biekens Groenten & Fruit

Elshout

Biekens
Groenten & Fruit



VAN BIJNEN 

TRANSPORT — LOGISTICS

- transport
- warehousing
- logistieke dienstverlening
- verhuur van bedrijfsruimte
- verhuur van kantoorruimte

www.vanbijnenlogistics.nl

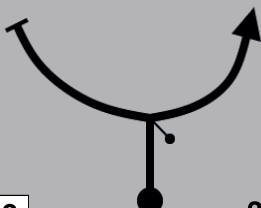
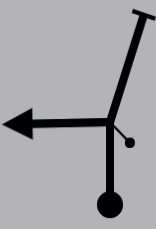
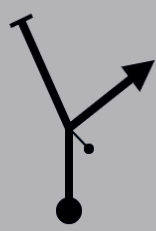
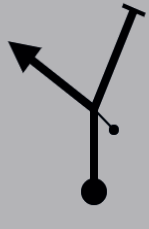

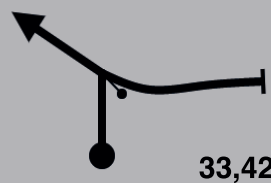
From TC 2 Lunch		DISTANCE: 49,49 Km		DAY: 21 mei 17	
To TC 3 Thee		RECORD: 3		SECTION: 3	
SPECIAL STAGE 2		TIME ALLOWED: min			
Heusden Langstraat Rally		49,49 Km			
DISTANCE		DIRECTION	INFORMATION	DISTANCE REGRESS	
TOTAL	PARTIAL				
15,40	1,53	 15 34,09			34,09
15,44	0,04	 16 34,05			34,05
15,71	0,27	 17 33,78	Orion		33,78
15,79	0,08	 18 33,70			33,70
15,93	0,14	 19 33,56			33,56
15,96	0,03	 20 33,53			33,53
16,07	0,11	 21 33,42			33,42

PROXIMA NOTA
PROCH NOTE
NEXT NOTE

0,05

TURN QUICKLY !!



van Hempt
BIO & DELICIOUS

**Lekker genieten van
heerlijke en
verantwoorde
voeding.**

Grotestraat 134, 5151 BN Drunen 0416-372497

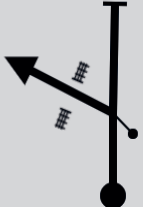
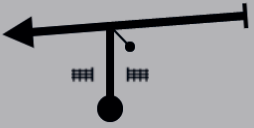
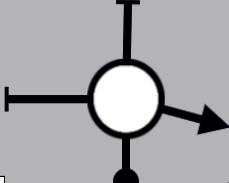

BuijsBestFoods

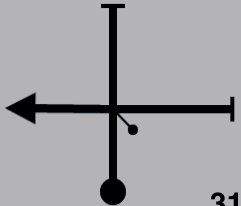
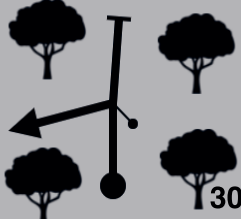
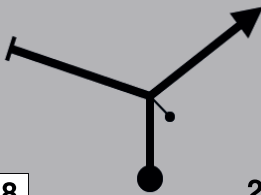
From TC 2 Lunch		DISTANCE: 49,49 Km		DAY: 21 mei 17	
To TC 3 Thee		RECORD: 3		SECTION: 3	
SPECIAL STAGE 2		TIME ALLOWED: min			
Heusden Langstraat Rally		49,49 Km			
DISTANCE		DIRECTION	INFORMATION	DISTANCE REGRESS	
TOTAL	PARTIAL				
16,12	0,05	 <div style="display: flex; justify-content: space-between; align-items: center;"> 22 33,37 </div>	<div style="border: 1px solid black; padding: 5px; display: inline-block;"> Ontheffin a </div>		33,37
16,36	0,24	 <div style="display: flex; justify-content: space-between; align-items: center;"> 23 33,13 </div>			33,13
16,95	0,59	 <div style="display: flex; justify-content: space-between; align-items: center;"> 24 32,54 </div>			32,54
17,52	0,57	 <div style="display: flex; justify-content: space-between; align-items: center;"> 25 31,97 </div>	Brug over Midden Brabant weg N261		31,97
18,23	0,71	 <div style="display: flex; justify-content: space-between; align-items: center;"> 26 31,26 </div>	Bergstraat		31,26
19,42	1,19	 <div style="display: flex; justify-content: space-between; align-items: center;"> 27 30,07 </div>			30,07
21,22	1,80	 <div style="display: flex; justify-content: space-between; align-items: center;"> 28 28,27 </div>	Vervolg Spinderspad		28,27

PROXIMA NOTA
PROCH NOTE
NEXT NOTE

2,77



JAMES

AUTO & SERVICE

0416 - 33 25 61

Grote complete beurt
€ 248,-
benzine personenauto



DE GRAAFF

AUTOBEDRIJVEN

Havenweg 21, Waalwijk

www.degraaff-waalwijk.nl

MaaK direct een afspraak, bel naar
0416 - 33 25 61 of mail naar
actie@degraaff-waalwijk.nl



ONDERHOUD ALLE MERKEN



Software Society
the support professionals

vermeulen & vermeulen
reclame sinds 1996

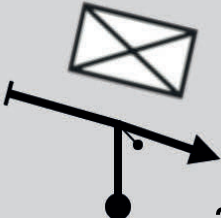
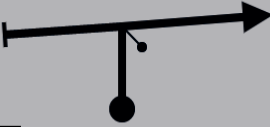
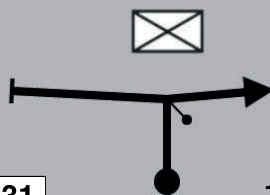
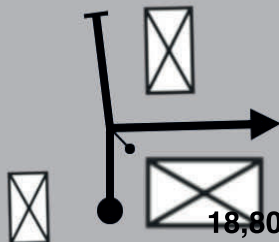
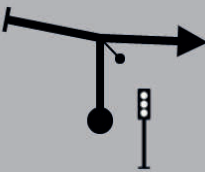
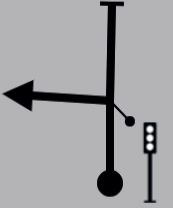
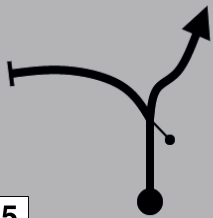
From TC 2 Lunch		DISTANCE: 49,49 Km		DAY: 21 mei 17	
To TC 3 Thee		RECORD: 3		SECTION: 3	
SPECIAL STAGE 2		TIME ALLOWED: min			
Heusden Langstraat Rally		49,49 Km			
DISTANCE		DIRECTION	INFORMATION	DISTANCE REGRESS	
TOTAL	PARTIAL				
23,99	2,77	 <div style="display: flex; justify-content: space-between; align-items: center;"> 29 25,50 </div>			25,50
25,94	1,95	 <div style="display: flex; justify-content: space-between; align-items: center;"> 30 23,55 </div>			23,55
30,52	4,58	 <div style="display: flex; justify-content: space-between; align-items: center;"> 31 18,97 </div>			18,97
30,69	0,17	 <div style="display: flex; justify-content: space-between; align-items: center;"> 32 18,80 </div>			18,80
31,38	0,69	 <div style="display: flex; justify-content: space-between; align-items: center;"> 33 18,11 </div>			18,11
31,88	0,50	 <div style="display: flex; justify-content: space-between; align-items: center;"> 34 17,61 </div>			17,61
31,97	0,09	 <div style="display: flex; justify-content: space-between; align-items: center;"> 35 17,52 </div>			17,52

PROXIMA NOTA
PROCH NOTE
NEXT NOTE

0,15

TURN QUICKLY !!

Lions Club



Een **Lions Club** (ook wel aan elkaar geschreven als *lionsclub*) is een charitatieve [club](#) waarvan de leden op vriendschappelijke basis samenwerken, dus zonder politieke, [godsdienstige](#) of beroepsmatige verbondenheid. Deze [serviceclubs](#) maken deel uit van de wereldwijde associatie [Lions International](#). Op vrijwillige basis ontplooiën de leden initiatieven voor een betere samenleving. Wereldwijd telt de organisatie bijna 1,35 miljoen leden, waarmee ze 's werelds grootste serviceorganisatie is. 192 landen tellen tezamen ruim 46.000 clubs. Voor personen in de leeftijdscategorie van 20 tot 35 jaar zijn er de [Leo Clubs](#).

Ontstaan

De eerste serviceclubs werden rond 1900 in de [Verenigde Staten](#) opgericht door mannen die zich inzetten voor goed burgerschap. Dit waren veelal 'businessman's circles'. Het was [Melvin Jones](#) (Fort Thomas (Arizona), 13 januari 1879 - Flossmoor (Illinois), 1 juni 1961) die in 1917 in [Dallas](#) (Texas) een groot aantal van die kringen bundelde tot de Association of Lions Clubs vanuit het idee dat een grote groep invloedrijke zakenmannen een machtig potentieel kan vormen in het belang van een betere samenleving. Toen ook in Canada Lions Clubs werden opgericht, werd de naam veranderd in The International Association of Lions Clubs, tegenwoordig kortweg Lions International. Na de [Eerste Wereldoorlog](#) werden ook Lions Clubs buiten [Noord-Amerika](#) opgericht.

Motto

Het internationale motto bij die activiteiten luidt "We serve". Vanuit die gedachte dragen Lions oplossingen aan voor problemen in de samenleving. Het gaat dan bijvoorbeeld om het realiseren van medische voorzieningen voor blinden, het terugdringen van diabetes, of het ondersteunen van scholen en ziekenhuizen. Nederlandse Lions richten zich vaak op het creëren van sportmogelijkheden voor kansarme kinderen, het organiseren en begeleiden van vakanties voor zieken en gehandicapten, financiële ondersteuning van [Cliniclowns](#), de [Zonnebloem](#), [Villa Pardoes](#), [Ronald McDonaldhuizen](#), et cetera.

Autonomie en samenstelling

Elke club opereert autonoom en bepaalt zelf hoe zij inhoud geeft aan de doelstellingen. Inbreng van (nieuwe) leden is daarbij essentieel omdat de synergie van gebundelde vaardigheden en inzet groter is dan de mogelijkheden van een enkel individueel lid. Nieuwe leden worden voorgedragen door minimaal twee reeds zittende leden. Het profiel van een club wordt mede bepaald doordat vaak niet meer dan twee leden uit eenzelfde beroepsgroep in een club mogen zitten.

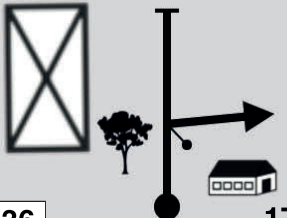
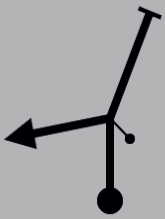
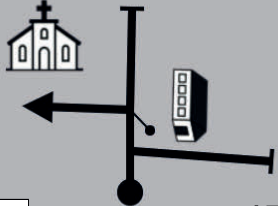
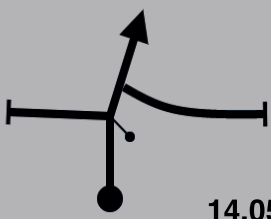
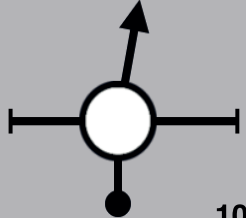
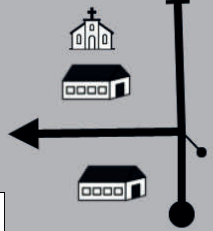
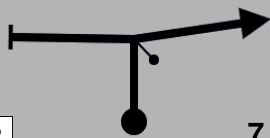
From TC 2 Lunch		DISTANCE: 49,49 Km		DAY: 21 mei 17	
To TC 3 Thee		RECORD: 3		SECTION: 3	
SPECIAL STAGE 2		TIME ALLOWED: min			
Heusden Langstraat Rally		49,49 Km			
DISTANCE		DIRECTION	INFORMATION	DISTANCE REGRESS	
TOTAL	PARTIAL				
32,12	0,15	 36 17,37	Galgeneind	17,37	
33,49	1,37	 37 16,00		16,00	
34,40	0,91	 38 15,09		15,09	
35,44	1,04	 39 14,05		14,05	
38,50	3,06	 40 10,99		10,99	
40,70	2,20	 41 8,79		8,79	
41,70	1,00	 42 7,79		7,79	

PROXIMA NOTA
PROCH NOTE
NEXT NOTE

2,78



Nederlandse Lions Clubs

De eerste Nederlandse Lions Clubs waren Amsterdam 1 Host (1951), Den Haag 1 (1952) en Rotterdam Host (1953). Nederland telt inmiddels zo'n 400 Lions Clubs met 11.500 leden, waarbij sinds de jaren 80 ook steeds meer vrouwen Lion worden. Om geld in te zamelen organiseren de Lions onder andere sportieve of culturele evenementen, bridgedrives, antiek- en curiosaveilingen, boekenmarkten en zeilwedstrijden die jaarlijks zo'n 7 miljoen euro opleveren. Daarnaast wordt er ook veel tijd en energie gestoken in immateriële dienstverlening.





Leo Clubs

Zowel studenten als werkenden in de leeftijd van 20 tot 35 jaar kunnen zich verenigen in een Leo Club, waarbij Leo staat voor *Leadership*, *Experience* en *Opportunity*. Voor het organiseren van activiteiten worden binnen de Leo Club commissies gevormd met afzonderlijke taken. Jonge leden krijgen zo de kans om organisatietalent te ontwikkelen. Elke Leo Club wordt gesponsord door een of meer Lions Clubs, zonder er deel van uit te maken. De Nederlandse Leo Clubs maken deel uit van Lions Clubs International en zijn verenigd in de Vereniging Leo Clubs Nederland. Internationaal zijn er 5500 Leo Clubs met ongeveer 140.000 leden.

Doelstellingen Lions Clubs International

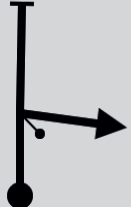
Lions worden aangemoedigd dienstbaar te zijn aan de gemeenschap, zonder oogmerk van persoonlijke materiële voordelen. De internationale doelstellingen zijn:

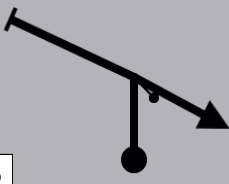
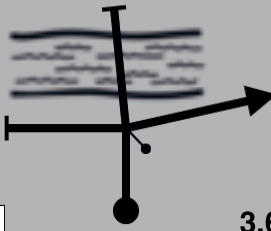
- Lions streven naar een klimaat van onderling begrip tussen de volkeren van de wereld.
- Zowel privé als in beroep hanteren Lions hoge ethische en morele normen.
- Ze bevorderen zo mogelijk de beginselen van goed overheids-bestuur en burgerzin.
- Lions tonen actieve belangstelling voor het maatschappelijk, cultureel, sociaal en moreel welzijn van de gemeenschap.
- Lionsclubs werken aan de onderlinge verbondenheid in vriendschap, kameraadschap en wederzijds begrip.
- De clubs bieden een ontmoetingsplaats voor vrije gedachtewisseling over zaken van openbaar belang. Daarbij worden discussies over partijpolitieke en religieuze opvattingen bewust uitgesloten.

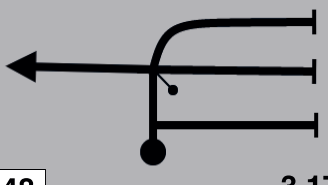
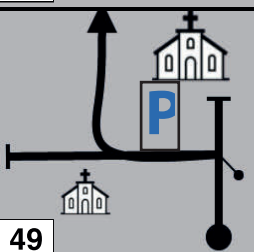
From TC 2 Lunch		DISTANCE: 49,49 Km		DAY: 21 mei 17	
To TC 3 Thee		RECORD: 3		SECTION: 3	
SPECIAL STAGE 2		TIME ALLOWED: min			
Heusden Langstraat Rally		49,49 Km			
DISTANCE		DIRECTION	INFORMATION	DISTANCE REGRESS	
TOTAL	PARTIAL				
44,48	2,78	 <div style="display: flex; justify-content: space-between; align-items: center;"> 43 5,01 </div>	Voshoornweg	5,01	
44,93	0,45	 <div style="display: flex; justify-content: space-between; align-items: center;"> 44 4,56 </div>		4,56	
45,41	0,48	 <div style="display: flex; justify-content: space-between; align-items: center;"> 45 4,08 </div>		4,08	
45,84	0,43	 <div style="display: flex; justify-content: space-between; align-items: center;"> 46 3,65 </div>		3,65	
46,01	0,17	 <div style="display: flex; justify-content: space-between; align-items: center;"> 47 3,48 </div>	Irenestraat	3,48	
46,32	0,31	 <div style="display: flex; justify-content: space-between; align-items: center;"> 48 3,17 </div>		3,17	
46,56	0,24	 <div style="display: flex; justify-content: space-between; align-items: center;"> 49 2,93 </div>		2,93	

PROXIMA NOTA
PROCH NOTE
NEXT NOTE

0,25



Wijnand van Delft

SFEERMAKERS SINDS 1994



 Partycentrum Wijnand van Delft

 Herberg De Drie Linden

 Grote BBQ

 Wijnand's catering

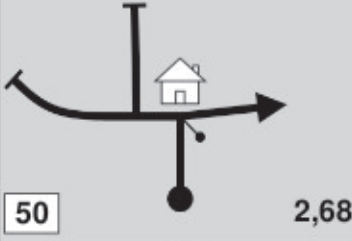
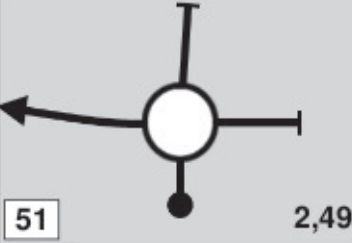
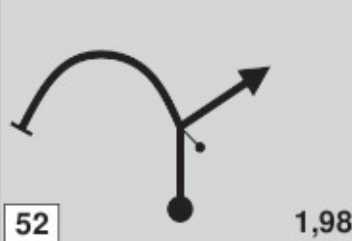
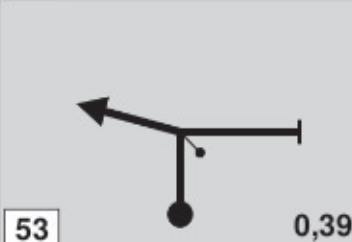
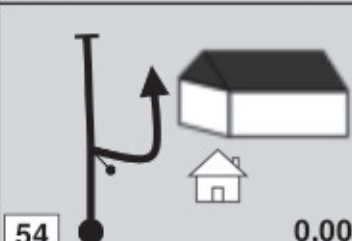
 De Pannenkoekenboerderij

From TC 2 Lunch		DISTANCE: 49,49 Km		DAY: 21 mei 17	
To TC 3 Thee				SECTION: 3	
SPECIAL STAGE		RECORD: 3		TIME ALLOWED: min	
Heusden Langstraat Rally		49,49 Km			
DISTANCE		DIRECTION	INFORMATION	DISTANCE REGRESS	
TOTAL	PARTIAL				
46,81	0,25				2,68
47,00	0,19				2,49
47,51	0,51		Polanenweg		1,98
49,10	1,59				0,39
1 49,49	0,39		 FINISH Heusden 49,49 Km  N-051°42.504 E-004°56.585 ALT: 1 m		0,00





Rondvaart
Wiljo



Feesten op het water

Of u nu met een klein gezelschap komt of met al uw vrienden of collega's.





Op onze twee schepen is uw bruiloft, jubileum, verjaardag of personeelsfeest in goede handen. Onze schepen liggen in het mooie oude vestingstadje Heusden.

www.rondvaartwiljo.nl

Rondvaart & dagtochten | Feesten & recepties | Huwelijksbootje | Bedrijfsevenementen | Dinars & buffetten | Actieve programma's

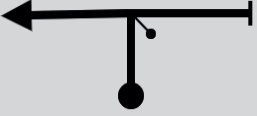

Rondvaart Wiljo | Vesting Heusden | T 0416 380 278 | E info@rondvaartwiljo.nl

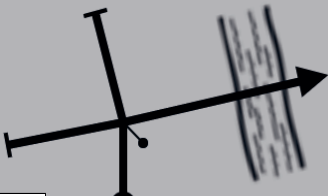
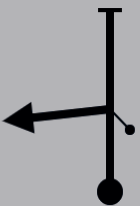
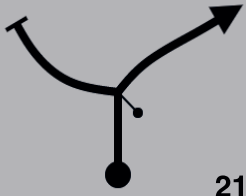
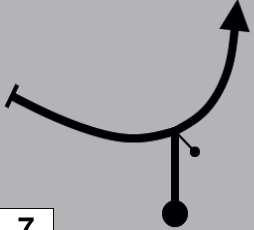
From TC 3 Thee		DISTANCE: 26,67 Km		DAY: 21 mei 17				
To TC 4 Finish		RECORD: 1		SECTION: 4				
SPECIAL STAGE 3		TIME ALLOWED: min						
Heusden Langstraat Rally 26,67 Km								
DISTANCE		DIRECTION	INFORMATION	DISTANCE REGRESS				
TOTAL	PARTIAL							
0,00	0,00	 1 26,67	 START SS 3 Heusden 26,67 Km  <table border="1" style="font-size: small;"> <tr><td>N-051°42.501</td></tr> <tr><td>E-004°56.558</td></tr> <tr><td>ALT: 1 m</td></tr> </table>	N-051°42.501	E-004°56.558	ALT: 1 m	26,67	
N-051°42.501								
E-004°56.558								
ALT: 1 m								
2,60	2,60	 2 24,07		24,07				
2,88	0,28	 3 23,79		23,79				
2,93	0,05	 4 23,74		23,74				
3,66	0,73	 5 23,01	Sasweg	23,01				
5,63	1,97	 6 21,04		21,04				
8,32	2,69	 7 18,35		18,35				

PROXIMA NOTA
PROCH NOTE
NEXT NOTE

0,71

SAMEN VOOR EEN DUURZAME SAMENLEVING

Duurzaamheid is meer dan techniek. Samen voor een betere samenleving. Door sport, spel, cultuur en sociaal contact, dichtbij. Daar gaan wij ook voor. Van Delft Groep steunt met plezier initiatieven die een duurzame samenleving stimuleren!



KLIMAATTECHNIEK

ELEKTROTECHNIEK

SANITAIRTECHNIEK

TECHNISCHBEHEER

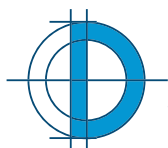

VAN DELFT GROEP

| Mandenmaker 18, Nieuwkuijk | Postbus 22, 5150 AA Drunen |

| T (073) 518 66 00 | F (073) 518 66 99 | www.vandelftgroep.nl | info@vandelftgroep.nl |

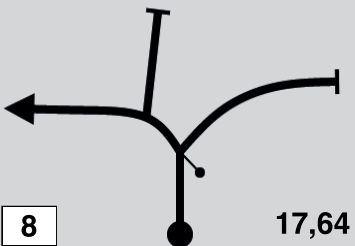
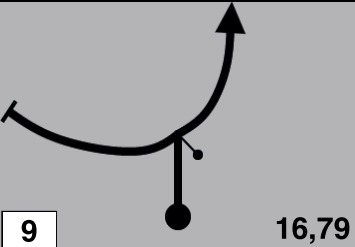
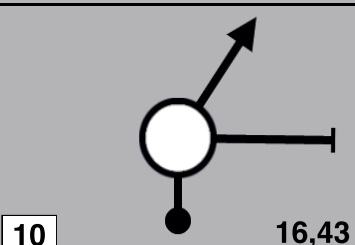
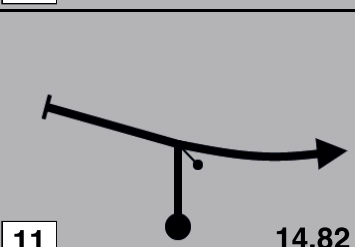
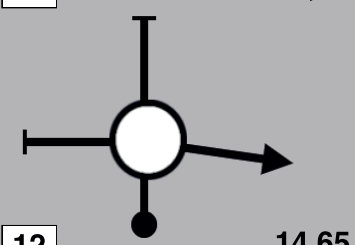
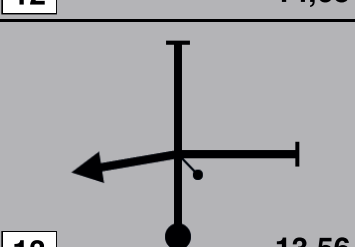
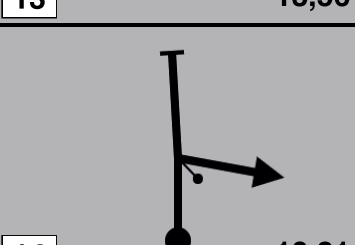

From TC 3 Thee		DISTANCE: 26,67 Km		DAY: 21 mei 17	
To TC 4 Finish		RECORD: 1		SECTION: 4	
SPECIAL STAGE 3		TIME ALLOWED: min			
Heusden Langstraat Rally		26,67 Km			
DISTANCE		DIRECTION	INFORMATION	DISTANCE REGRESS	
TOTAL	PARTIAL				
9,03	0,71		Raadhuisstraat	17,64	
9,88	0,85			16,79	
10,24	0,36			16,43	
11,85	1,61		Van Kerkstraat naar Kerkstraat	14,82	
12,02	0,17			14,65	
13,11	1,09			13,56	
15,86	2,75		Jan van Eycklaan	10,81	

PROXIMA NOTA
PROCH NOTE
NEXT NOTE

0,24





AUTOBEDRIJF MOONEN

*Al 40 jaar
ervaring in Citroën*

Scheidingstraat 4, 5154 AG Elshout - Drunen
tel. 0416 375 591
www.autobedrijfmoonen.nl

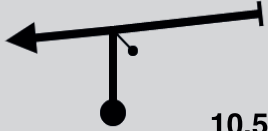

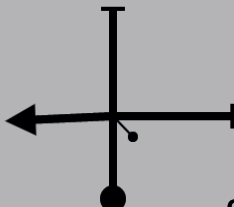
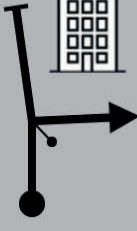
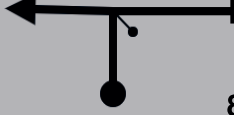
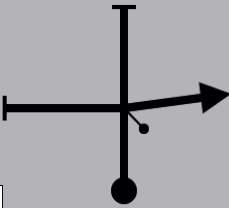
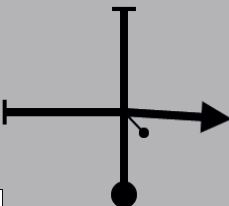
From TC 3 Thee		DISTANCE: 26,67 Km		DAY: 21 mei 17	
To TC 4 Finish		RECORD: 1		SECTION: 4	
SPECIAL STAGE 3		TIME ALLOWED: min			
Heusden Langstraat Rally		26,67 Km			
DISTANCE		DIRECTION	INFORMATION	DISTANCE REGRESS	
TOTAL	PARTIAL				
16,10	0,24	 15 10,57			10,57
16,43	0,33	 16 10,24			10,24
16,98	0,55	 17 9,69			9,69
17,46	0,48	 18 9,21			9,21
17,73	0,27	 19 8,94			8,94
18,02	0,29	 20 8,65			8,65
19,46	1,44	 21 7,21	Kanaalweg		7,21

PROXIMA NOTA
PROCH NOTE
NEXT NOTE **3,33**

Groenewoud 34 Drunen * 0416 373159





ASPERGES & KOOKSTUDIO

Vlaamsche Hofstee

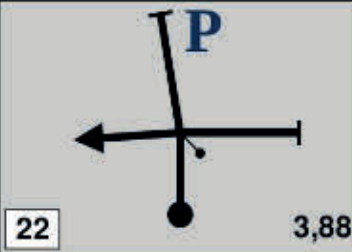
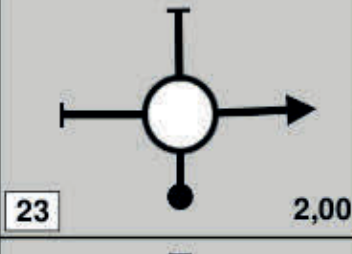
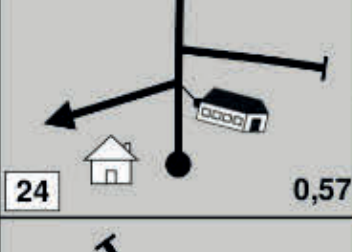
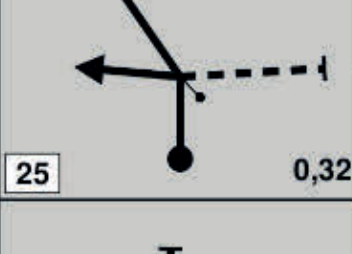

Tot ziens!

Rini en Carien van Rooij

From TC 3 Thee		DISTANCE: 26,67 Km		DAY: 21 mei 17	
To TC 4 Finish				SECTION: 4	
SPECIAL STAGE 3		RECORD: 1		TIME ALLOWED: min	
Heusden Langstraat Rally 26,67 Km					
DISTANCE		DIRECTION	INFORMATION	DISTANCE REGRESS	
TOTAL	PARTIAL				
22,79	3,33	 22 3,88			3,88
24,67	1,88	 23 2,00			2,00
26,10	1,43	 24 0,57			0,57
26,35	0,25	 25 0,32			0,32
1 26,67	0,32	 26 0,00	 FINISH Heusden 26,67 Km		0,00
			 N-051°41.398 E-005°09.654 ALT: 4 m		

BuijsBestFoods

ARNO DUNGEN

HOUTHANDEL DHZ NIEUWE & GEBRUIKTE BOUWMATERIALEN - CONTAINERSERVICE

ARNO DUNGEN

S L O O P - E N G R O N D W E R K E N

ARNO DUNGEN

S L O O P - E N G R O N D W E R K E N B V

Sloopwerken • Asbestsanering

Grondwerken • Bodemsanering

Lambertusstraat 11a | 5256 TB Hedikhuizen

info@arnovddungen.nl | T 073-5112630

www.arnovddungen.nl

ARNO DUNGEN

SLOOP- & GRONDWERKEN / ASBEST- & BODEMSANERING



Lokaal
betrokken!



Samen met u maken we
de Langstraat sterker

Rabobank De Langstraat



Rabobank

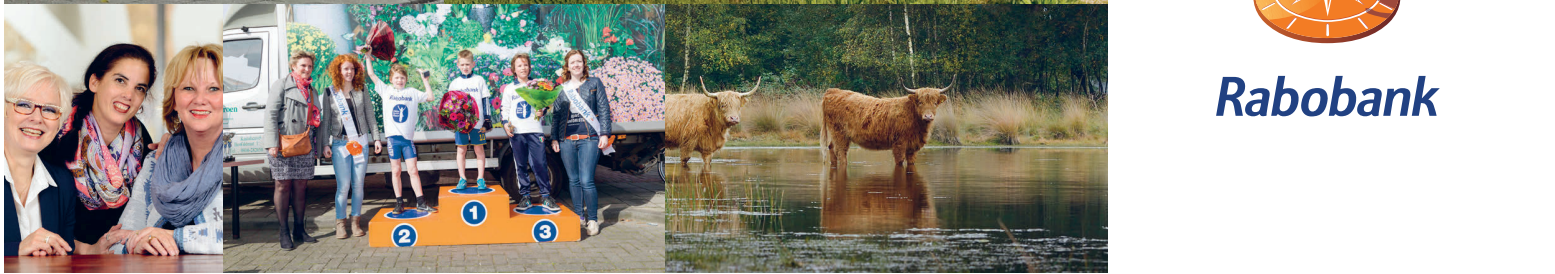

“Heel soms heb je meer aan **PK's** dan aan **MB's**”

Wij wensen iedereen een veilige rally!



Al jaren zijn wij marktleider in de internationale fitnessindustrie. Aan hen leveren wij software en diensten voor de ondersteuning van de administratieve taken. Door te kiezen voor nieuwe wegen hebben wij succesvolle oplossingen bedacht. Laat ons ook rennen voor uw bedrijf, want onze softwareontwikkelingen en ons efficiënte hardwarebeheer zijn ook toepasbaar in uw branche.

We werken al meer dan 30 jaar voor anderen.

Dit jaar voor u?